

316 EC-H 12 Litronic[®] LIEBHERR Hammerhead Tower Crane

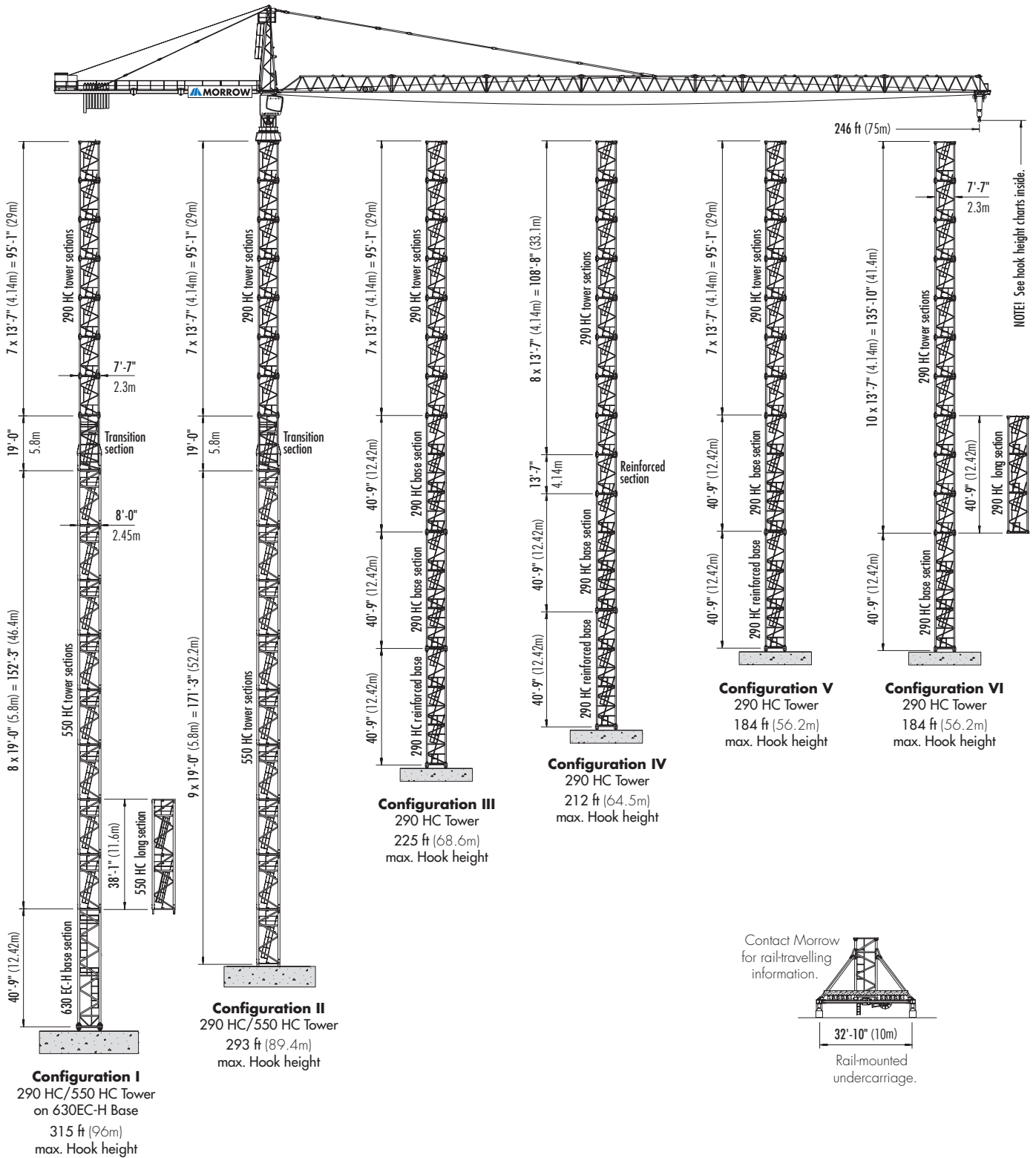

Jib Layout

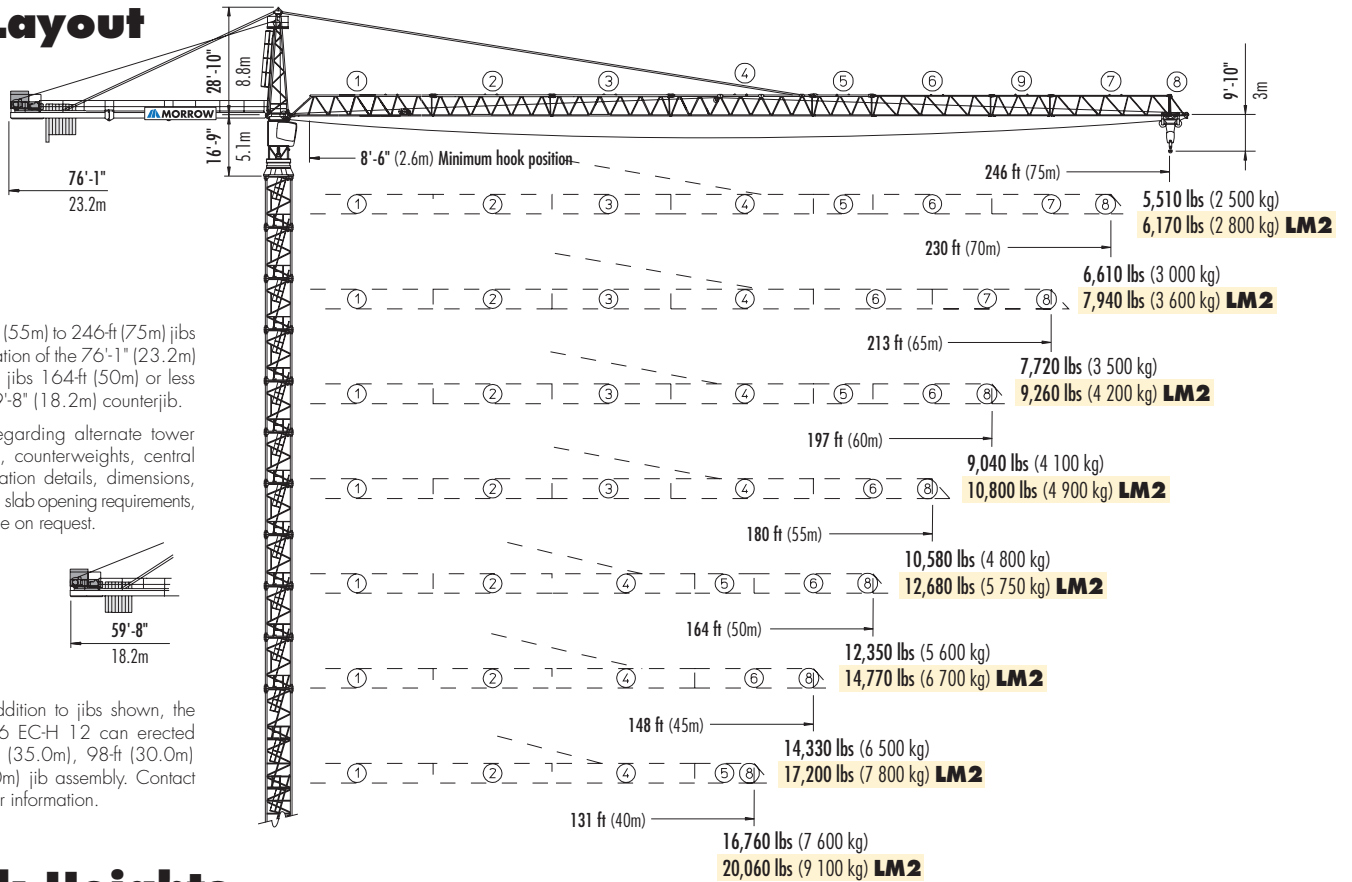

Hook Heights

Configuration I ¹						
No. of Tower Elements		Tower Element Type	static concrete footing		rail-travelling undercarriage	
			feet	meters	feet	meters
1	630EC-H BS	48	14.7	76	23	
2	550HC STS	67	20.5	95	28.8	
3	550HC STS	86	26.3	114	34.6	
4	550HC STS	105	32.1	133	40.4	
5	550HC STS	125	37.9	152	46.2	
6	550HC STS	144	43.7	171	52	
7	550HC STS	163	49.5	190	57.8	
8	550HC STS	182	55.3	209	63.6	
9	550HC STS	201	61.1	228	69.4	
10	Transition	220	66.9	247	75.2	
11	290HC STS	233	71.1	260	79.4	
12	290HC STS	247	75.2	274	83.5	
13	290HC STS	260	79.4	288	87.6	
14	290HC STS	274	83.5	301	91.8	
15	290HC STS	288	87.6	315	95.9	
16	290HC STS	301	91.8	328	100.1	
17 ^{3,5}	290HC STS	315	96			

Configuration II						
No. of Tower Elements		Tower Element Type	static concrete footing		rail-travelling undercarriage	
			feet	meters	feet	meters
1	550HC STS	27	8.3	54	16.4	
2	550HC STS	46	14.1	73	22.2	
3	550HC STS	65	19.9	92	28	
4	550HC STS	84	25.7	111	33.8	
5	550HC STS	103	31.5	130	39.6	
6	550HC STS	122	37.3	149	45.4	
7	550HC STS	142	43.1	168	51.2	
8	550HC STS	161	48.9	187	57	
9	550HC STS	180	54.7	206	62.8	
10	Transition	199	60.5	225	68.6	
11	290HC STS	212	64.7	239	72.7	
12	290HC STS	226	68.8	252	76.9	
13	290HC STS	239	72.9	266	81	
14	290HC STS	253	77.1	279	85.2	
15	290HC STS	267	81.2	293	89.3	
16	290HC STS	280	85.4	307	93.4	
17 ^{3,5}	290HC STS	293 ¹	89.4 ¹	320 ^{1,4}	97.6 ^{1,4}	

Hook Heights

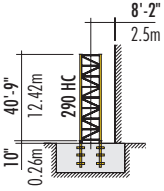
Configuration III ¹			
290 HC on 40'-9" (12.42m) reinforced base section LM1 ONLY			
No. of Tower Elements	Tower Element Type	static concrete footing	
		feet	meters
1	290HC RBS	49	14.8
2	290HC BS	89	27.2
3	290HC BS	130	39.6
4	290HC STS	144	43.7
5	290HC STS	157	47.9
6	290HC STS	171	52
7	290HC STS	184	56.2
8	290HC STS	198	60.3
9	290HC STS	212	64.5
10	290HC STS	225	68.6

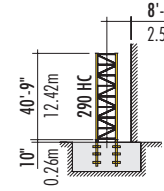
Configuration IV ¹			
290 HC on 40'-9" (12.42m) reinforced base section LM1 ONLY			
No. of Tower Elements	Tower Element Type	static concrete footing	
		feet	meters
1	290HC RBS	49	14.8
2	290HC BS	89	27.2
3	290HC RTS	103	31.3
4	290HC STS	116	35.5
5	290HC STS	130	39.6
6	290HC STS	144	43.8
7	290HC STS	157	47.9
8	290HC STS	171	52
9	290HC STS	184	56.1
10	290HC STS	198	60.3
11	290HC STS	212	64.5

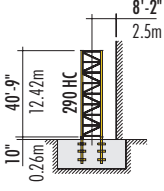
Configuration V ^{6, 1}			
290 HC on 40'-9" (12.42m) reinforced base section			
No. of Tower Elements	Tower Element Type	static concrete footing	
		feet	meters
1	290HC RBS	49	14.8
2	290HC BS	89	27.2
3	290HC STS	103	31.3
4	290HC STS	116	35.5
5	290HC STS	130	39.6
6	290HC STS	144	43.8
7	290HC STS	157	47.9
8	290HC STS	171	52
9 ³	290HC STS	184	56.2

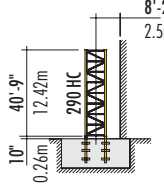
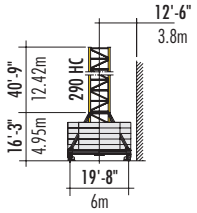
Configuration VI					
290 HC on 40'-9" (12.42m) standard base section					
No. of Tower Elements	Tower Element Type	static concrete footing		rail-travelling undercarriage	
		feet	meters	feet	meters
1	290HC BS	49	14.8	64	19.4
2	290HC STS	62	18.9	77	23.6
3	290HC STS	75	23	91	27.7
4	290HC STS	89	27.2	105	31.9
5	290HC STS	103	31.3	118	36
6	290HC STS	116	35.5	132	40.1
7	290HC STS	130	39.6	145	44.3
8	290HC STS	144	43.8	159	48.4
9	290HC STS	157	47.9	173	52.6
10 ⁵	290HC STS	171 ^{2.5}	52 ^{2.5}	186 ^{24.5}	56.7 ^{24.5}
11 ⁵	290HC STS	184 ^{23.5}	56.2 ^{23.5}	—	—

NOTE:

- ¹ Configuration is without top climbing unit.
- ² Lower top climbing unit to base of tower prior to operating crane.
- ³ Crane must not be operated at this hook height if wind speed exceeds 40mph (64kph).
- ⁴ No other crane operations permitted when travelling.
- ⁵ Heavy lift mode (LM2) NOT permitted at this hook height.
- ⁶ 180ft to 246ft (55m to 75m) hook reach only.

Alternate tower combinations are possible. Refer to Operation manual or contact MORROW for information.

Consult crane Operation Manual before erecting, operating, servicing, climbing or dismantling crane.

Specifications subject to change without prior notice. For additional information, contact MORROW.

Tie-in Details

NOTE: For information regarding bottom climbing inside of structure, please contact Morrow.

NOTE: Restrictions apply; please consult Operations Manual or Morrow engineering.

¹ **LM1:** For hook heights below 330 ft (100m), a maximum of 9 tower sections may be installed above uppermost tie-in location. If hook height exceeds 330 ft (100m), a maximum of 8 tower sections may be installed.

² **LM2:** A maximum of 7 tower sections may be installed above uppermost tie-in location.

³ Lower top climbing unit to upper tie-in assembly prior to operating crane.

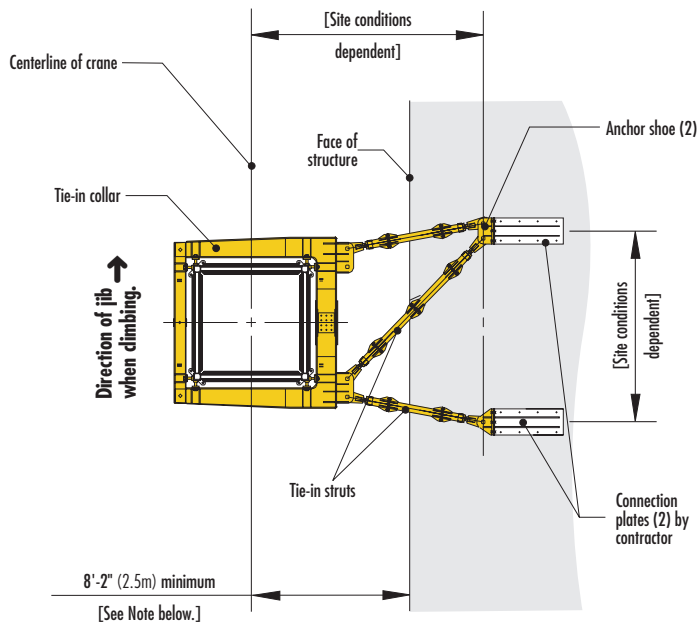

**TIE-IN ASSEMBLY
with 290 HC Tower Sections**
plan view

NOTE: The tie-in assembly shown is an example of a typical installation when using 290HC tower. Please note, however, that factors determining the installation of tie-in assemblies may vary due to project specific requirements.

Verify all dimensions.

Contact Morrow for additional information regarding dimensions, alternate tower configurations, reactions forces, tie-in installation and slab opening requirements.

Consult Operation Manual before erecting, operating, servicing or dismantling crane.

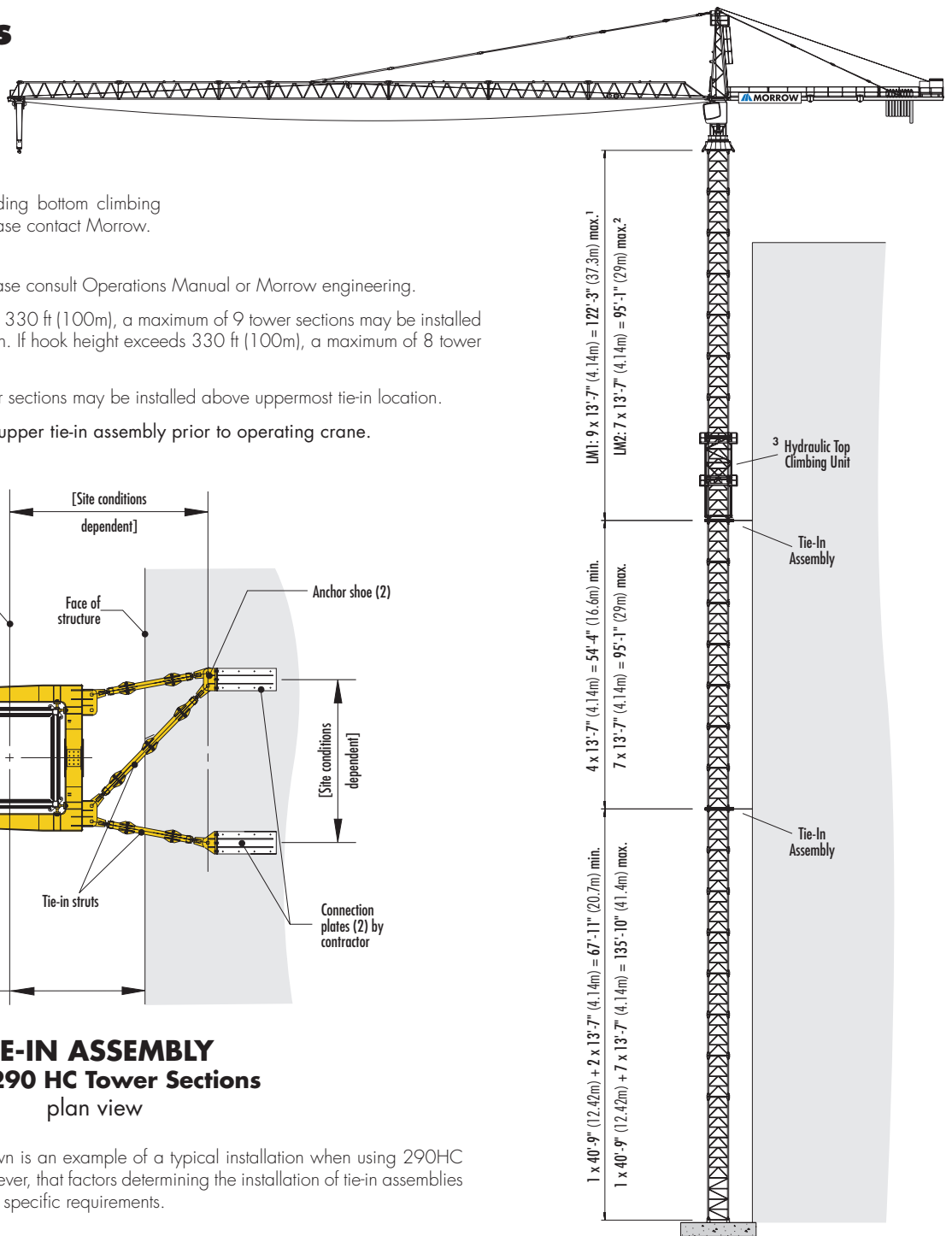

**TOP CLIMBING
with 290 HC Tower Sections**
tied to structure

Radius and Capacities

2-Part Line	Hook Radius	Jib Tip Radius	Maximum Capacity – Radius	ft m	72 22	82 25	92 28	102 31	112 34	121 37	131 40	148 45	164 50	180 55	197 60	213 65	230 70	246 75
	246 ft 75m	251'-4" 76.6m	26,460 lbs – 70 ft 12 000 kg – 21.2m	lbs kg	25,350 11 500	21,940 9 950	19,290 8 750	17,130 7 770	15,370 6 970	13,910 6 310	12,650 5 740	10,960 4 970	9,590 4 350	8,470 3 840	7,540 3 420	6,770 3 070	6,080 2 760	5,510 2 500
	230 ft 70m	234'-11" 71.6m	26,460 lbs – 73 ft 12 000 kg – 22.4m	lbs kg	26,460 12 000	23,410 10 620	20,590 9 340	18,320 8 310	16,470 7 470	14,900 6 760	13,580 6 160	11,770 5 340	10,320 4 680	9,150 4 150	8,160 3 700	7,320 3 320	6,610 3 000	
	213 ft 65m	218'-6" 66.6m	26,460 lbs – 76 ft 12 000 kg – 23.3m	lbs kg	26,460 12 000	24,450 11 090	21,520 9 760	19,160 8 690	17,220 7 810	15,590 7 070	14,220 6 450	12,320 5 590	10,820 4 910	9,610 4 360	8,580 3 890	7,720 3 500		
	197 ft 60m	202'-1" 61.6m	26,460 lbs – 80 ft 12 000 kg – 24.3m	lbs kg	26,460 12 000	25,570 11 600	22,510 10 210	20,040 9 090	18,030 8 180	16,340 7 410	14,900 6 760	12,940 5 870	11,380 5 160	10,100 4 580	9,040 4 100			
	180 ft 55m	185'-8" 56.6m	26,460 lbs – 83 ft 12 000 kg – 25.2m	lbs kg	26,460 12 000	26,460 12 000	23,460 10 640	20,900 9 480	18,810 8 530	17,060 7 740	15,560 7 060	13,540 6 140	11,900 5 400	10,580 4 800				
	164 ft 50m	169'-4" 51.6m	26,460 lbs – 85 ft 12 000 kg – 25.9m	lbs kg	26,460 12 000	26,460 12 000	24,250 11 000	21,610 9 800	19,440 8 820	17,640 8 000	16,120 7 310	14,020 6 360	12,350 5 600					
	148 ft 45m	152'-11" 46.6m	26,460 lbs – 87 ft 12 000 kg – 26.4m	lbs kg	26,460 12 000	26,460 12 000	24,760 11 230	22,070 10 010	19,860 9 010	18,030 8 180	16,470 7 470	14,330 6 500						
	131 ft 40m	136'-6" 41.6m	26,460 lbs – 88 ft 12 000 kg – 26.8m	lbs kg	26,460 12 000	26,460 12 000	25,150 11 410	22,440 10 180	20,220 9 170	18,340 8 320	16,760 7 600							

LM 1
Standard mode

2-Part Line	Hook Radius	Jib Tip Radius	Maximum Capacity – Radius	ft m	72 22	82 25	92 28	102 31	112 34	121 37	131 40	148 45	164 50	180 55	197 60	213 65	230 70	246 75
	246 ft 75m	251'-4" 76.6m	26,460 lbs – 75 ft 12 000 kg – 22.9m	lbs kg	26,460 12 000	23,940 10 860	21,080 9 560	18,740 8 500	16,840 7 640	15,260 6 920	13,910 6 310	12,060 5 470	10,580 4 800	9,370 4 250	8,380 3 800	7,520 3 410	6,810 3 090	6,170 2 800
	230 ft 70m	234'-11" 71.6m	26,460 lbs – 84 ft 12 000 kg – 25.6m	lbs kg	26,460 12 000	26,460 12 000	23,940 10 860	21,340 9 680	19,200 8 710	17,420 7 900	15,900 7 210	13,820 6 270	12,170 5 520	10,820 4 910	9,700 4 400	8,750 3 970	7,940 3 600	
	213 ft 65m	218'-6" 66.6m	26,460 lbs – 88 ft 12 000 kg – 26.7m	lbs kg	26,460 12 000	26,460 12 000	25,130 11 400	22,400 10 160	20,170 9 150	18,320 8 310	16,730 7 590	14,570 6 610	12,830 5 820	11,420 5 180	10,250 4 650	9,260 4 200		
	197 ft 60m	202'-1" 61.6m	26,460 lbs – 92 ft 12 000 kg – 27.9m	lbs kg	26,460 12 000	26,460 12 000	26,320 11 940	23,480 10 650	21,160 9 600	19,200 8 710	17,570 7 970	15,300 6 940	13,490 6 120	12,040 5 460	10,800 4 900			
	180 ft 55m	185'-8" 56.6m	26,460 lbs – 95 ft 12 000 kg – 29.1m	lbs kg	26,460 12 000	26,460 12 000	26,460 12 000	24,650 11 180	22,200 10 070	20,170 9 150	18,450 8 370	16,090 7 300	14,220 6 450	12,680 5 750				
	164 ft 50m	169'-4" 51.6m	26,460 lbs – 98 ft 12 000 kg – 30m	lbs kg	26,460 12 000	26,460 12 000	26,460 12 000	25,550 11 590	23,040 10 450	20,940 9 500	19,160 8 690	16,710 7 580	14,770 6 700					
	148 ft 45m	152'-11" 46.6m	26,460 lbs – 101 ft 12 000 kg – 30.8m	lbs kg	26,460 12 000	26,460 12 000	26,460 12 000	26,240 11 900	23,680 10 740	21,520 9 760	19,690 8 930	17,200 7 800						
	131 ft 40m	136'-6" 41.6m	26,460 lbs – 103 ft 12 000 kg – 31.3m	lbs kg	26,460 12 000	26,460 12 000	26,460 12 000	26,460 12 000	24,100 10 930	21,910 9 940	20,060 9 100							

LM 2
Heavy lift mode

IMPORTANT: Litronic® cranes are equipped with Liebherr's state of the art PLC system that provides precise monitoring, control and coordination of all cranes functions. This feature also permits a load increase of up to 20% as illustrated in the heavy lift mode (LM2) chart above. Contact Morrow for more information regarding the many features of the 316 EC-H 12 Litronic tower crane.

Foundation Details on concrete footing

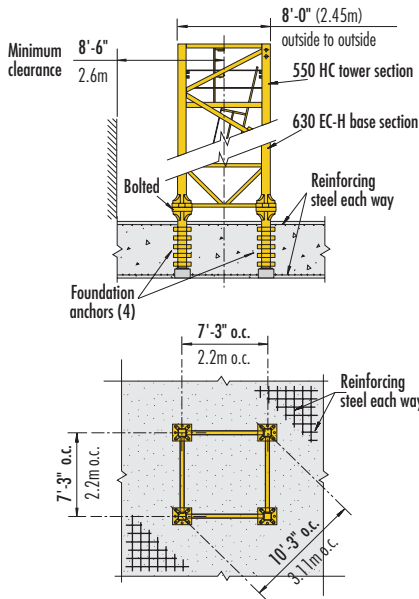

on 630 EC-H Base Section

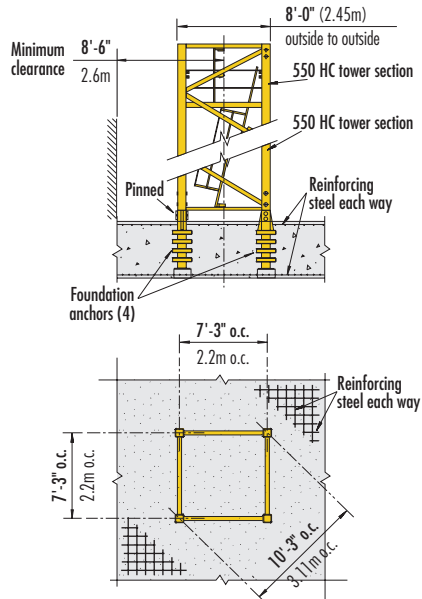

with 550 HC Tower

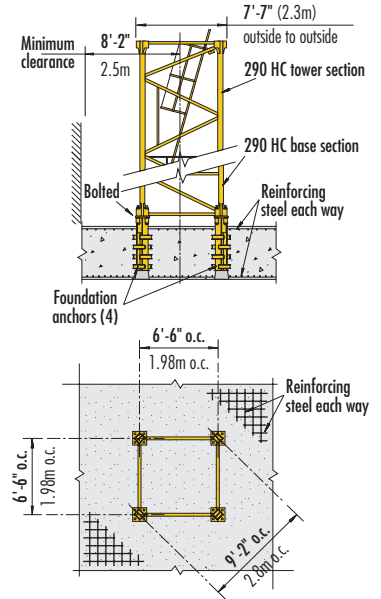

with 290 HC Tower

Undercarriage Details on rail-travelling undercarriage

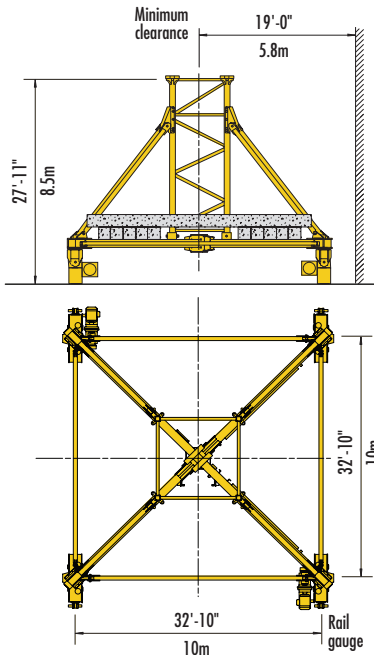

630 EC-H

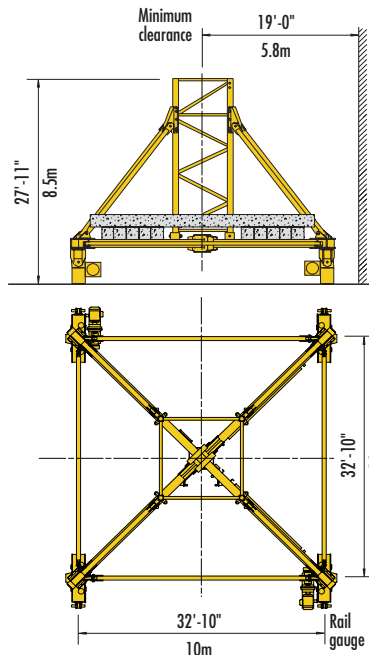

550 HC

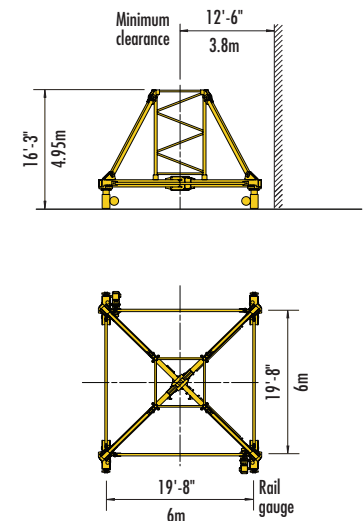

290 HC

NOTE: For information regarding rail-travelling, static undercarriages and central ballast configurations, see 316 EC-H Litronic Operation Manual.

Hoist Speed and Capacity

Hoist Unit	2-Part Line				LM 1
	Capacity	Hook Speed	Capacity	Hook Speed	
147 hp (110 kW) FC hoist unit Variable frequency drive (VFD) 8L - 242	26,460 lbs	@ 0 - 157 fpm	12 000 kg	@ 0 - 48m/min	
	14,110 lbs	@ 0 - 272 fpm	6 400 kg	@ 0 - 83m/min	
	11,900 lbs	@ 0 - 315 fpm	5 400 kg	@ 0 - 96m/min	
	6,170 lbs	@ 0 - 545 fpm	2 800 kg	@ 0 - 166m/min	
	2,870 lbs	@ 0 - 906 fpm	1 300 kg	@ 0 - 276m/min	

IMPORTANT: Capacities and line speeds indicated will vary depending on the amount of hoist wire rope installed. This crane model may be equipped with a hoist unit other than that specified in the data shown above. To verify, check serial number and refer to 316 EC-H 12 Litronic Operation Manual for additional information.

Motor Information

Drive Unit	Horsepower	Kilowatts	Speed	
Trolley (VFD)	10 hp	7.5 kW	0 - 360 fpm	0 - 110m/min
Swing (VFD)	2 x 10 hp	2 x 7.5 kW	0.7 rpm	
Travelling (290 HC)	2 x 10 hp	2 x 7.5 kW	82 fpm	25m/min
Travelling (550 HC)	4 x 10 hp	4 x 7.5 kW	82 fpm	25m/min

Counterweights*

Counterjib	76-ft (23.2m)					60-ft (18.2m)		
	246-ft (75m)	230-ft (70m)	213-ft (65m)	197-ft (60m)	180-ft (55m)	164-ft (50m)	148-ft (45m)	131-ft (40m)
No. of blocks	1E + 8A	7A + 2B	6A + 2B	7A	6A	8A + 1B	6A + 2B	6A + 1B
Weight in lbs	51,030 lbs	46,410 lbs	41,450 lbs	40,010 lbs	35,050 lbs	48,170 lbs	41,450 lbs	38,250 lbs
Weight in kg	23 150 kg	21 050 kg	18 800 kg	18 150 kg	15 900 kg	21 850 kg	18 800 kg	17 350 kg

NOTE: Weight of the A Block is 4,960 lbs (2 250 kg); the B Block is 3,200 lbs (1 450 kg); the D Block is 5,290 lbs (2 400 kg), and the E Block is 6,060 lbs (2 750 kg). Counterweights must be installed from rear to front, i.e. towards the tower. It is recommended that the weight of each counterweight be verified before installation. Counterweight figures displayed in the chart above are for crane with hoist unit WiV 300 VZ 410 installed. If another hoist unit is installed, refer to the Liebherr 316 EC-H 12 Litronic Operation Manual or contact Morrow Equipment for additional information.

* **IMPORTANT:** One (1) D Block must be installed beneath the hoist unit frame of the counterjib.

Power Requirements

Power supply: 3-phase 480 V, 60 Hz; 3-wire plus ground; no Neutral.

480 V phase-phase, 277 V each phase to ground with 120° phase shift between phases.











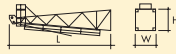
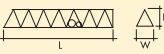
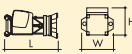
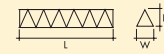
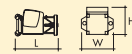
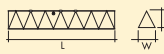

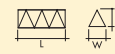

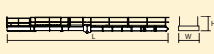
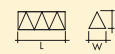

Service size: 200 Amperes

NOTES:

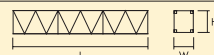
- For electric power provided by an electric utility, do not use open Delta transformers.
- For electric power provided by a generator, the minimum generator size required is 200 kW. Verify the generator provided is suitable for use with variable frequency drives (VFDs). A properly sized generator is critical to the safe operation of the crane.

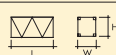
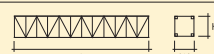
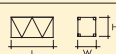
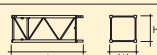
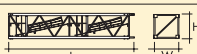
Specifications subject to change without prior notice. For additional information, contact MORROW.

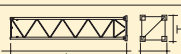
Component List

Description	Dimensions L x W x H	Weight	Description	Dimensions L x W x H	Weight
Tower Top 	29'-9" x 5'-9" x 6'-4" 9.05m x 1.76m x 1.94m	6,170 lbs 2 800 kg	Jib Section ① ^{7,8} C051.023.611.111 	40'-3" x 6'-1" x 6'-5" 12.26m x 1.86m x 1.96m	6,450 lbs 2 930 kg
Slewing Assembly (Complete) ¹ 	18'-0" x 9'-0" x 9'-2" 5.49m x 2.74m x 2.8m	22,490 lbs 10 200 kg	Jib Section ②③ ⁸ #621 	33'-7" x 5'-5" x 6'-2" 10.26m x 1.65m x 1.88m	4,140 lbs 1 880 kg
Slewing Assembly Upper Part ² 	14'-11" x 9'-0" x 9'-2" 4.54m x 2.74m x 2.8m	14,550 lbs 6 600 kg	Jib Section ④ ^{7,8} C051.023.629.111 	40'-4" x 5'-5" x 6'-1" 12.28m x 1.65m x 1.87m	4,500 lbs 2 040 kg
Slewing Assembly Lower Part ³ 	3'-9" x 9'-0" x 7'-9" 1.15m x 2.74m x 2.36m	7,940 lbs 3 600 kg	Jib Section ⑤ ⁸ #632 	17'-5" x 5'-5" x 6'-1" 5.32m x 1.65m x 1.87m	1,810 lbs 820 kg
Hoist Unit (VFD) ⁴ 147 hp (110 kW) 	9'-5" x 7'-3" x 6'-9" 2.88m x 2.22m x 2.07m	9,040 lbs 4 100 kg	Jib Section ⑥ ⁸ #633 	33'-8" x 5'-5" x 6'-1" 10.27m x 1.65m x 1.87m	2,690 lbs 1 220 kg
Counterjib A ⁵ 	54'-9" x 8'-0" x 5'-7" 16.7m x 2.45m x 1.7m	17,420 lbs 7 900 kg	Jib Section ⑨ ⁸ #635 	17'-3" x 5'-5" x 6'-0" 5.25m x 1.65m x 1.84m	1,120 lbs 510 kg
Counterjib B ⁶ 	71'-2" x 8'-0" x 5'-7" 21.7m x 2.45m x 1.7m	21,380 lbs 9 700 kg	Jib Section ⑦ ⁸ #634 	33'-7" x 5'-5" x 6'-0" 10.26m x 1.65m x 1.84m	1,760 lbs 800 kg
Counterweight Block A with frame 	4'-4" x 11" x 7'-9" 1.31m x 0.28m x 2.35m	4,960 lbs 2 250 kg	Jib Section ⑧ ⁸ #641 	5'-7" x 6'-2" x 6'-9" 1.7m x 1.88m x 2.05m	630 lbs 285 kg
Counterweight Block B with frame 	4'-4" x 11" x 4'-9" 1.31m x 0.28m x 1.46m	3,200 lbs 1 450 kg	Jib Assembly ^{7,9} 246 ft (75m) ①②③④⑤⑥⑨⑦⑧	246'-9" x 6'-2" x 6'-9" 75.2m x 1.88m x 2.05m	35,710 lbs 16 200 kg
Counterweight Block E ⁷ with frame 	4'-4" x 11" x 8'-9" 1.31m x 0.28m x 2.67m	6,060 lbs 2 750 kg	Jib Assembly ⁹ 230 ft (70m) ①②③④⑤⑥⑦⑧	230'-4" x 6'-2" x 6'-9" 70.2m x 1.88m x 2.05m	34,170 lbs 15 500 kg
Base Section 290HC 	40'-9" x 7'-7" x 7'-7" 12.42m x 2.3m x 2.3m	17,500 lbs 7 940 kg	Jib Assembly ⁹ 213 ft (65m) ①②③④⑥⑦⑧	213'-11" x 6'-2" x 6'-9" 65.2m x 1.88m x 2.05m	33,070 lbs 15 000 kg
Long Tower Sect. 290HC 	40'-9" x 7'-7" x 7'-7" 12.42m x 2.3m x 2.3m	12,720 lbs 5 770 kg	Jib Assembly ⁹ 197 ft (60m) ①②③④⑤⑥⑧	197'-6" x 6'-2" x 6'-9" 60.2m x 1.88m x 2.05m	32,190 lbs 14 600 kg
Standard Tower Section 290HC 	13'-7" x 7'-7" x 7'-7" 4.14m x 2.3m x 2.3m	5,070 lbs 2 300 kg	Jib Assembly ⁹ 180 ft (55m) ①②③④⑥⑧	181'-1" x 6'-2" x 6'-9" 55.2m x 1.88m x 2.05m	29,760 lbs 13 500 kg
Reinforced Base 290HC 	40'-9" x 7'-7" x 7'-7" 12.42m x 2.3m x 2.3m	16,400 lbs 7 440 kg	Jib Assembly ⁹ 164 ft (50m) ①②④⑤⑥⑧	164'-8" x 6'-2" x 6'-9" 50.2m x 1.88m x 2.05m	26,230 lbs 11 900 kg
Reinforced Tower Section 290HC 	13'-7" x 7'-7" x 7'-7" 4.14m x 2.3m x 2.3m	6,500 lbs 2 950 kg	Jib Assembly ⁹ 148 ft (45m) ①②④⑥⑧	148'-4" x 6'-2" x 6'-9" 45.2m x 1.88m x 2.05m	24,470 lbs 11 100 kg
Std. Tower Section 550HC 	20'-7" x 8'-0" x 8'-0" 6.28m x 2.45m x 2.45m	14,290 lbs 6 480 kg	Jib Assembly ⁹ 131 ft (40m) ①②④⑤⑧	131'-11" x 6'-2" x 6'-9" 40.2m x 1.88m x 2.05m	22,270 lbs 10 100 kg
Long Tower Sect. 550HC 	39'-8" x 8'-0" x 8'-0" 12.1m x 2.45m x 2.45m	23,480 lbs 10 650 kg	Transition (P/B) 550HC/290HC 	20'-7" x 8'-5" x 8'-5" 6.28m x 2.57m x 2.57m	13,050 lbs 5 920 kg
Base Section 630EC-H (B/P) 	40'-9" x 8'-10" x 8'-10" 12.42m x 2.68m x 2.68m	31,970 lbs 14 500 kg	Top Climbing Unit & Hydraulics (290HC) 	27'-7" x 9'-2" x 8'-10" 8.42m x 2.79m x 2.69m	16,530 lbs 7 500 kg

NOTE: Weights and dimensions are approximate. Scale components before lifting. Consult Operation Manual before erecting, operating, servicing or dismantling crane.

¹ Slewing Assembly Complete includes cab, platforms, 2 swing motors, slewing ring with support and 4 non-detachable climbing shoes. Dimensions include climbing shoes in transport position.
² Slewing Assembly Upper Part includes operator' cab, platforms and two swing motors.
³ Slewing Assembly Lower Part includes slewing ring, slewing ring support and four non-detachable climbing shoes. Dimensions shown above are with climbing shoes in transport position.
⁴ Includes 147 hp (110 kW) VFD hoist drive with rope drum, switchgear panels, hoist unit frame and wire rope. Typical rope installation of 790 ft (240m) weighs about 1,110 lbs (505 kg).
⁵ Counterjib A includes sections #1 (4,980 lbs/2 260 kg), #3 (6,880 lbs/3 120 kg), connecting material, pendant bars, handrails and D block. Counterjib A is required for jibs 164 ft (50m) and shorter. D block is 5,290 lbs (2 400 kg).
⁶ Counterjib B includes sections #1, #2 (3,420 lbs/1 550 kg), #3, connecting material, pendant bars, handrails and D block. Counterjib B is required for jibs 180 ft (55m) and longer. D block weighs 5,290 lbs (2 400 kg).
⁷ IMPORTANT: Counterweight block E plus jib sections C051.023-611.111 and C051.023-629.111 required when installing 246 ft (75m) jib. **SEE MANUAL FOR INFORMATION. VERIFY ALL COMPONENTS BEFORE INSTALLING.**
⁸ Jib layout details provided in 316EC-H12 Litronic Operation Manual. **IMPORTANT:** Please verify all jib components PRIOR to assembly and installation.
⁹ Jibs include jib sections, pendant bars, pendant bar connecting pins and plates, trolley drive unit, trolley wire rope, hook block and trolley. See footnote 7 regarding 246 ft (75m) jib.

@MorrowEquipment:



www.morrow.com
 info@morrow.com
 (503) 585 - 5721



MEC-MKT-1294 2/15/19